

THANK YOU FOR YOUR PURCHASE
PLEASE READ THESE INSTRUCTIONS CAREFULLY PRIOR TO INSTALLATION / MAINTENANCE

SPECIFICATIONS

- LED:** In-built SMD 2835 Elite LED Chips (45 pcs)
- Colour Temperature:** 5000K (Cool White)
- Wattage:** 6W
- Lumen Output:** 720lm
- LED Life Expectancy:** up to 50,000 hours
- Sensor:** Light / Charge Sensor
- IP Rating:** IP65
- Projection:** 90 degrees beam angle / 1m width (approx.)
- Battery Type:** Lithium Ion Phosphate (LiFePO4) 3.2V 12Ah (only replaceable by manufacturer)
- Battery Lifespan:** up to 8 years
- Battery Charge Time:** 6-8 hours (full sunshine)
- Max Illumination Time from Full Charge:** Up to 23 hrs (2-3 nights)
- Solar Panel:** 5V 10W Monocrystalline (Grade A)
- Materials:** Aluminium, Polycarbonate, Tempered Glass
- Weight:** 2.257kg (exc. support plates) / 2.414kg (inc. support plates)
- Mounting:** Surface mount (multiway) / adjustable tilt
- Outreach of bracket:** Up to 260mm (adjustable)
- Default Function:** 1 hour at 100%, 2 hours at 80%, 2 hours at 50%, 9 hours at 30% (dusk to dawn)
- Remote Control:** 1.5m range – Additional functions (brightness, timer, dusk to dawn, override) – CR2025 inc.
- Working Temperature:** -25° ~ 65°C
- Included:** Solar Light, 2x L-brackets, 2x support / mounting plates, 2 x bracket bolt sets, 4 x support mount bolt sets, Remote Control
- Required:** 5mm allen key, mounting screws / bolts

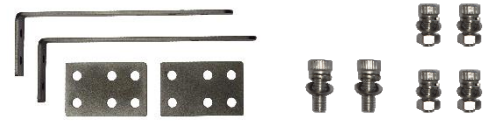
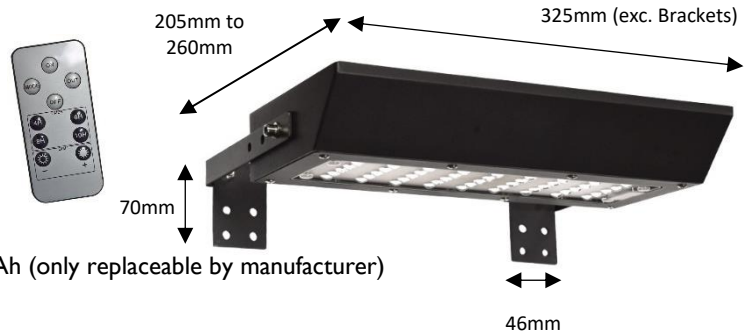

✓✓✓✓
5 YEAR
GUARANTEE
see website for
more details



UK REGISTERED DESIGN: 6250124

Producer Registration Numbers: WEE/KC3440XY / BPRN0843

! WARNINGS !

- If a fitting is found to be damaged, cease use immediately.
- The unit may get warm whilst on for a period of time.
- Always take care when installing your solar light, especially when mounting it in high places.
- Ensure the fitting is mounted out of range of head height to avoid injury.
- Fitting must be mounted to a solid surface.
- This Solar Light will not charge correctly if the panel is behind glass or artificial light is used.
- For replacement battery, contact the manufacturer. Do not attempt to change the battery or wiring.

CLEANING & MAINTENANCE:

Occasional cleaning and care is recommended for this product. Wipe with a soft, slightly damp cloth to remove any surface dirt. To maintain efficiency, specifically clean the solar panel and LEDs on a regular basis. Also, keep the solar panel free of debris and snow to prevent reduced battery life or malfunction. Do not use abrasive cleaners or a lot of water as this could damage the fitting. Please refer to our website for more information on the best way to clean different materials.

RETURNS / RECYCLING:

If purchased from a 3rd party, please contact your supplier. If purchased direct, contact us by phone or email:
Lumena Lights Ltd, Centre 33 Long March, Daventry, NN11 4NR Tel: +44 1327 871161 Email: sales@lumenalights.com
Our full returns policy is available on our website.

Waste Electrical Products should not be disposed of with household waste. Please check with your local authority or contact us for more information. Please recycle packaging whenever possible.



INSTALLATION:

Location – It is important that the installation location is carefully considered, avoiding shady areas. The best position is south facing, however the light can work facing in other directions, especially when in full sunshine. Ensure there are no other lights which could interfere with the Sensors, imitating daylight. When installed near eaves, use maximum outreach.

1. Attach the L-brackets to the light fitting with the 2 x socket bolts, lock washers and washers provided. For the highest outreach, use the outer hole (can be amended after installation) – see Fig. 1.
2. Continue to your chosen install method below.

Mounting to a wall/surface with support plate (recommended)

1. Use the support plate to determine the final position of the light and mark each hole on the wall.
2. Attach the support plate to the L-brackets using the 4 x socket bolts, lock washers, washer and nuts provided (see fig. 2). It is recommended that the bolts attaching the plate to the light pass through the centre support holes to even weight proportion.
3. Drill out a 10mm depth hole with a 10-12mm drill to create a recess to enable the support plate – L-brackets bolt heads to recess into the wall. Alternatively additional mounting screws can be used in all 6 holes (see fig. 3)
4. Drill out the 2-4 holes relevant to your chosen M5/6 screws (not supplied). If securing with 2 screws per support, it is recommended to use the outer top and inner bottom holes (see fig. 3).
5. Secure the support brackets to the surface.

Mounting to a wall / surface without support plate

6. Hold the light with L brackets in position and mark the position of the mounting holes on the wall.
7. Drill out the holes relevant to your chosen M5/6 screws (not supplied).
8. Secure L-brackets to the surface (see fig. 4)

Sign mounting from behind using support plate as riser

1. Attach the support plate to the L-brackets using the 4 x socket bolts, lock washers, washer and nuts provided using the top 2 holes (see fig. 5). The L-brackets will be located above the sign to prevent any obstruction to graphics.
2. Use the support plate to determine the final position of the light and mark 2 of 4 holes per support on the front of the sign ensuring they do not obstruct any important part of the graphics. It is recommended to use the outer top and inner bottom holes. (max. M6). Also check the back of the sign to ensure there are no obstructions for the bolts to pass through.
3. Drill out the 4 holes with 6.5mm drill bit
4. Secure the support brackets to the surface.

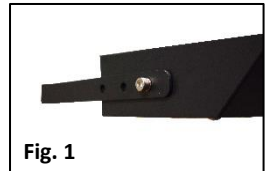

Fig. 1

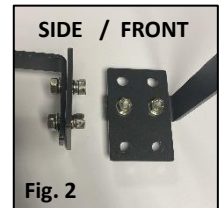

Fig. 2

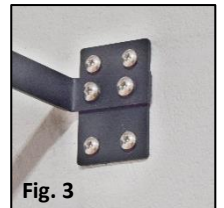

Fig. 3

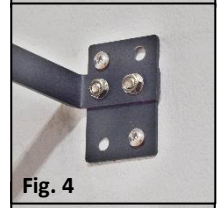

Fig. 4



Fig. 5

FUNCTION / CHARGING:

If installing the fitting later on in the day, leave the fitting turned off until the following morning to ensure a full day of charge prior to first use.

The Signa will only function during darkness / dusk. The on button only needs to be pressed once for the fitting to work thereafter.

TURNING UNIT ON/OFF

Turn on the fitting via the button on the left side of the fitting and leave to charge for a full day (cover solar panel to test)



GRADUAL DIMMING SEQUENCE: 100% brightness for first hour, reduces to 80% for 2 hours, reduces to 50% for 2 hours, reduces to 30% for 9 hours, then off. If low battery is detected, the fitting will enter Smart Power Mode and brightness will reduce to 30% or less until battery charge is exhausted or charge is boosted.

One full charge provides enough power for multiple nights for when there is little light during the day. On partially cloudy / rainy days, it will continue to re-charge but at a slower rate. The high lumen light output is bright enough to illuminate entrances and signs up to 1m width with it's 90 degree beam angle.

REMOTE CONTROL

Remove battery tab protector before first use.

Use the remote control to adjust brightness, override and function. See image ►
Point the remote towards the receiver on the LED panel within 1.5m range and press the relevant button firmly. Light will flash to confirm function adjustment.

STORAGE:

When storing this solar light, be sure to turn it to the off position by following the above steps (test by covering the solar panel). Max. 6 months storage when fully charged – recharge will be required periodically to prevent damage to battery over long periods of time.

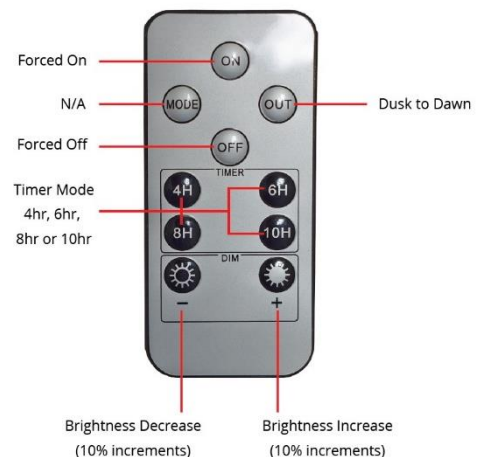
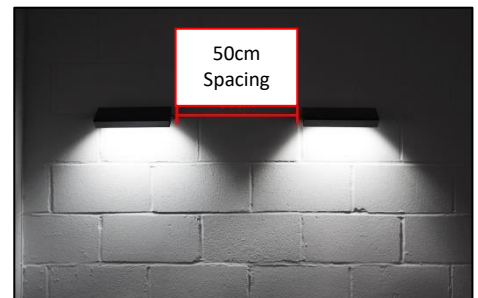

Full product range & more information: www.lumenalights.com